

Обозначение	Площадь сечения	Масса 1 п.м.	Площадь покрытия	Справочные величины для осей					
				X-X			Y-Y		
				J	W	I	J	W	I
				см ⁴	см ³	см	см ⁴	см ³	см
ТП-50310	6.55	1.77	0.21	40.94	9.41	2.5	18.11	7.24	1.66
ТП-50311	7.67	2.07	0.26	96.75	16.99	3.55	24.57	9.82	1.79
ЭК-5002	6.91	1.8	0.31	80.64	15.22	3.42	23.04	9.22	1.83
ТП-50312	8.55	2.31	0.31	161.42	23.88	4.35	29.64	11.85	1.86
ТП-50313	9.35	2.52	0.35	238.1	30.78	5.05	34.25	13.7	1.91
ТП-50314	12.75	3.44	0.42	482.2	48.86	6.15	51.12	20.45	2.0
ТП-50314-01	14.32	3.87	0.60	667.34	61.13	6.83	57.34	22.94	2.01
ТП-50314-02	15.32	4.14	0.64	857.79	71.94	7.48	62.99	25.2	2.03
ТП-5013Н	6.24	2.59							
ТП-5013-01	7.6	2.05							
ТП-5013-02Н	7.6	2.05							
ТП-5013-03Н	9.3	2.511							
ТП-5013-04Н	11.55	3.12							
ТП-5015-05Н	12.55	3.39							
ТП-5013-06Н	13.75	3.71							

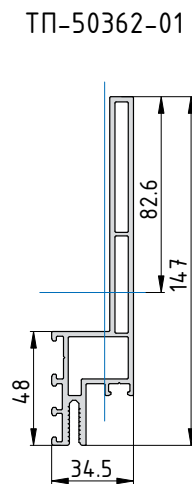

Обозначение	Площадь сечения	Масса 1 п.м.	Площадь покрытия	Справочные величины для осей					
				X-X			Y-Y		
				J	W	I	J	W	I
				см ⁴	см ³	см	см ⁴	см ³	см
ЭК-5016	9.76	2.64	0.39	92.23	16.01	3.1	84.1	15.5	2.94
ТП-50316	7.33	1.98	0.18	33.96	8.27	2.15	33.95	8.28	2.15
ТП-50317	4.57	1.23	0.19	34.12	7.45	2.73	5.08	1.75	1.05
ТП-50318	6.01	1.62	0.19	60.06	10.99	3.16	6.81	2.73	1.07
ТП-50317, ТП-50318	10.57	2.85		101.15	25.74	3.93	25.56	16.39	1.56
ТП-50360	1.86	0.5	0.12						
ТП-50362	7.1	1.92	0.35	96.97	13.42	3.7	8.98	4.26	1.12
ТП-50362-01	8.63	2.33	0.38	160.40	19.56	4.31	10.20	4.63	1.09
ТП-50365	4.03	1.09	0.16	5.09	2.64	1.12	8.52	3.39	1.45
ТП-50366	5.24	1.42	0.23	7.17	3.91	1.17	24.37	5.66	2.16
ТП-50370	4.2	1.13	0.22	6.3	2.14	1.22	10.2	3.65	1.56

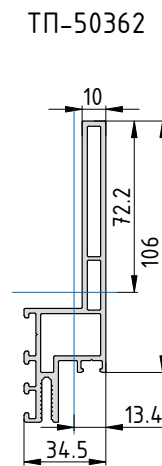
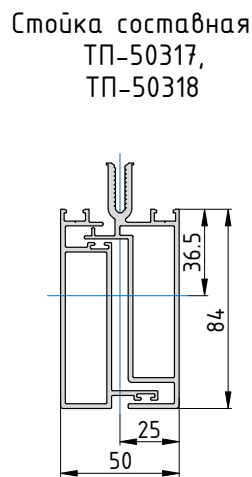
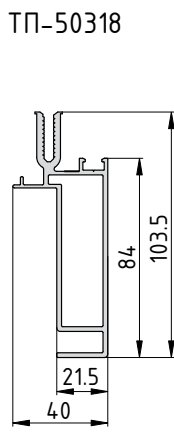
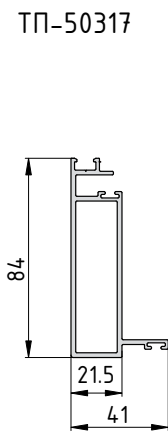
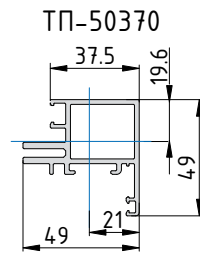
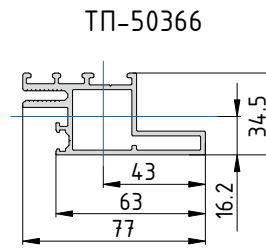
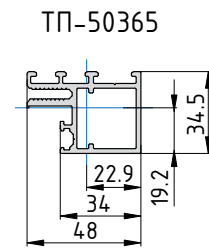
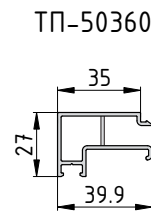
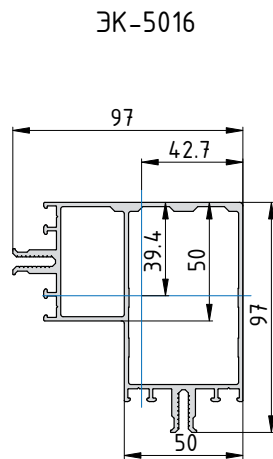
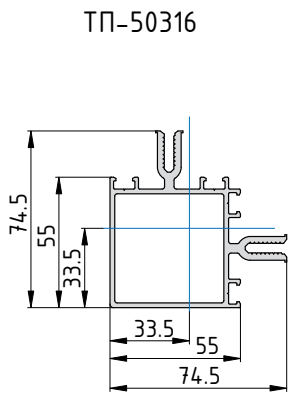
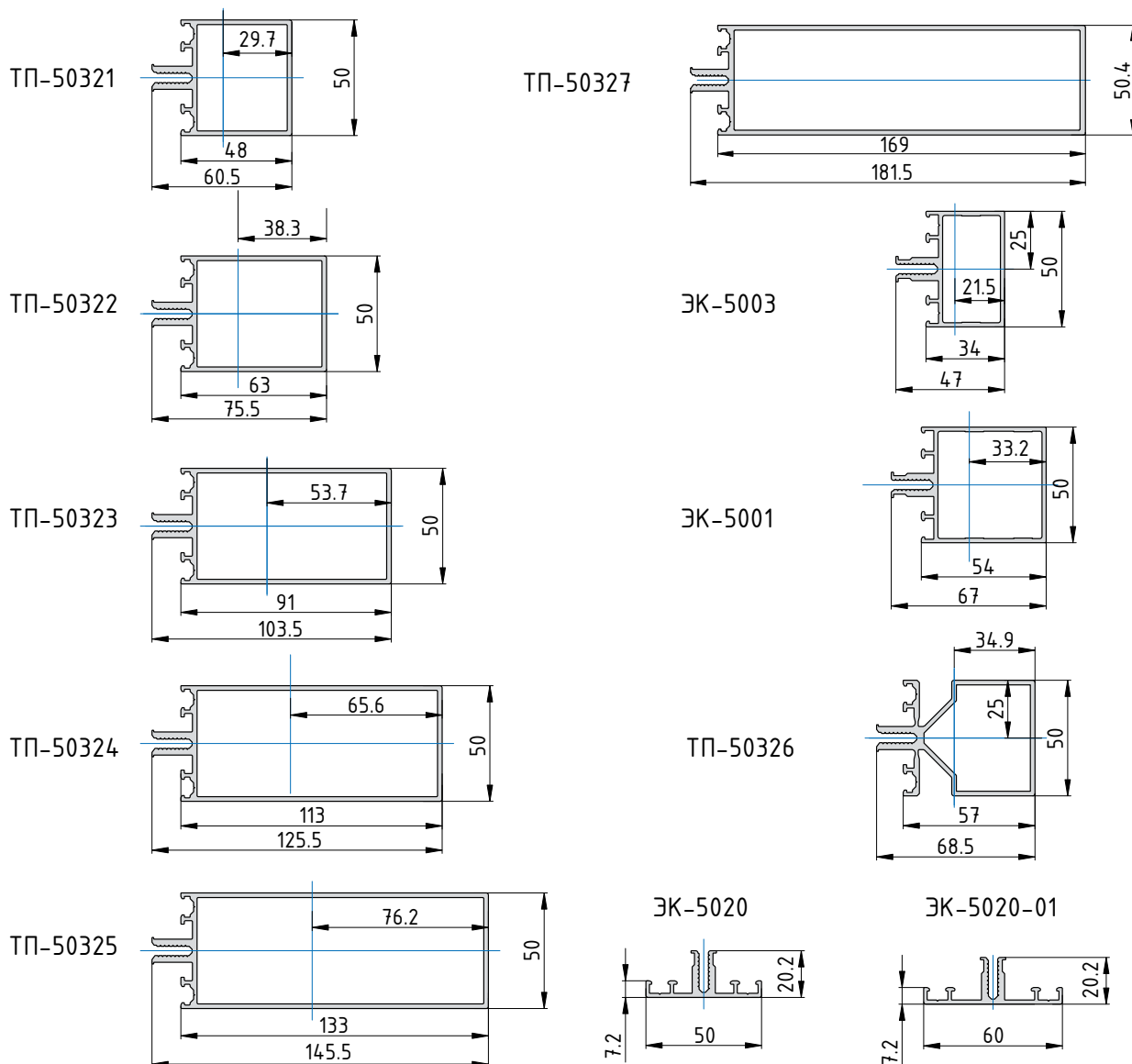

Обозначение	Площадь сечения	Масса 1 п.м.	Площадь покрытия	Справочные величины для осей					
				X-X			Y-Y		
				J	W	I	J	W	I
				см ⁴	см ³	см	см ⁴	см ³	см
ТП-50321	5	1.35	0.18	14.76	5.9	1.72	19	6.17	1.95
ТП-50322	5.6	1.51	0.21	18.22	7.29	1.8	35.05	9.16	2.5
ТП-50323	6.72	1.82	0.26	24.67	9.87	1.92	82.15	15.29	3.5
ТП-50324	7.6	2.05	0.40	29.75	11.90	1.98	137.28	20.93	4.25
ТП-50325	8.40	2.27	0.43	34.36	13.74	2.02	203.22	26.66	4.92
ТП-50326	5.87	1.59	0.25	15.4	6.16	1.62	27.47	7.86	2.16
ТП-50327	10.98	2.96	0.42	47.73	18.94	2.09	411.95	43.88	6.13
ЭК-5001	4.91	1.24	0.25	15.16	6.06	1.76	22.88	6.77	2.16
ЭК-5003	4.15	1.05	0.24	8.25	3.23	1.41	10.79	4.32	1.67
ЭК-5020	2.31	0.62	0.15	0.71	0.48	0.55	3.45	1.38	1.22
ЭК-5020-01	2.49	0.67	0.22	0.74	0.5	0.55	5.65	1.88	1.51

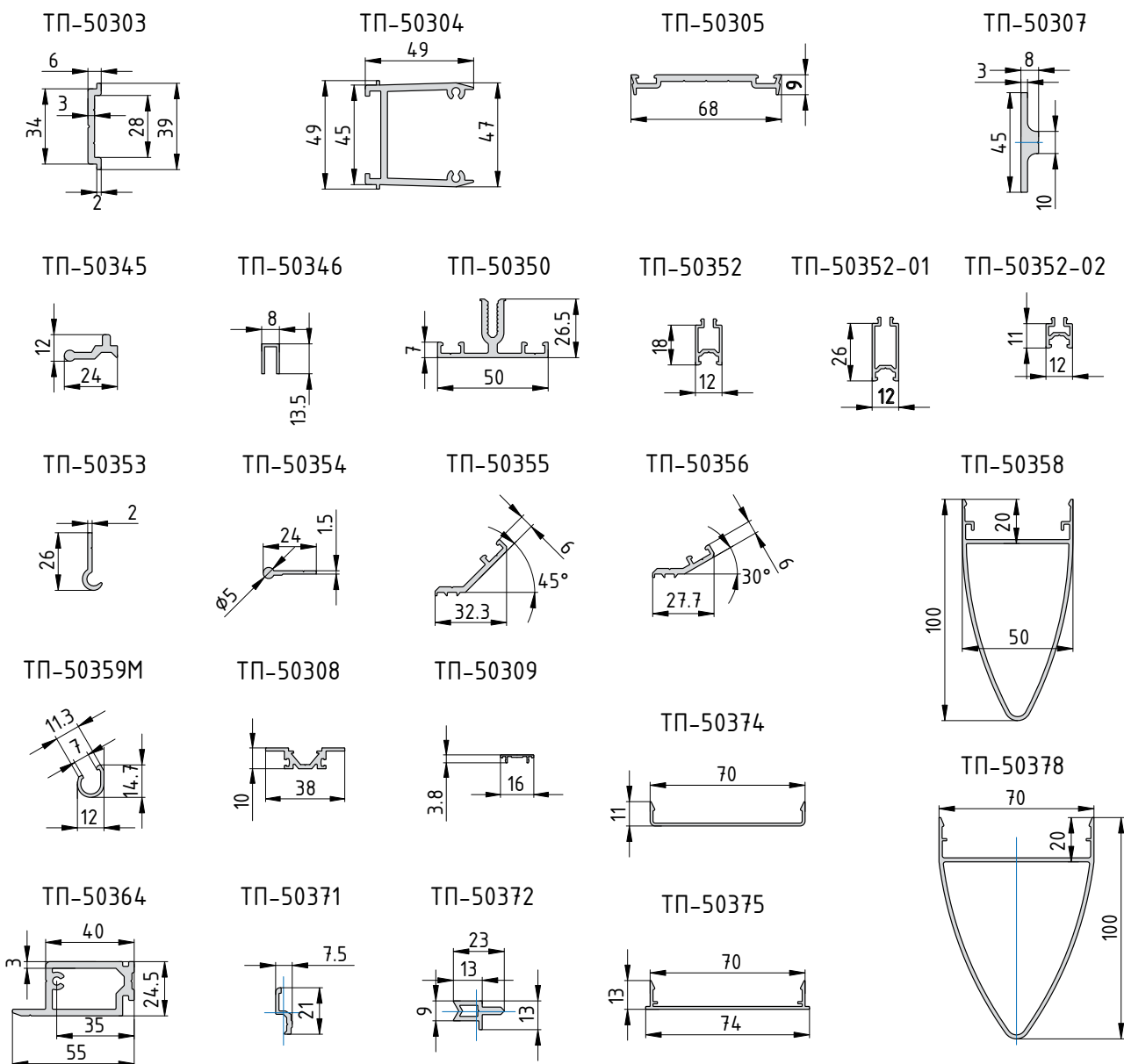

Обозначение	Площадь сечения	Масса 1 п.м.	Площадь покрытия
	см ²	кг	м ² /п.м.
ТП-50303	1,28	0,34	
ТП-50304	4,35	1,11	
ТП-50305	2,15	0,58	0,2
ТП-50307	1,92	0,52	0,12
ТП-50345	1,05	0,28	
ТП-50346	0,47	0,11	
ТП-50350	2,74	0,74	0,06
ТП-50352	0,78	0,22	0,05
ТП-50352-01	0,97	0,28	0,07
ТП-50352-02	0,61	0,17	0,04
ТП-50353	0,64	0,17	0,07
ТП-50354	0,50	0,14	0,06

Обозначение	Площадь сечения	Масса 1 п.м.	Площадь покрытия
	см ²	кг	м ² /п.м.
ТП-50355	1,13	0,31	0,08
ТП-50356	0,84	0,23	0,07
ТП-50358	0,45	0,126	0,32
ТП-50359М	0,45	0,13	0,07
ТП-50364	4,26	1,15	
ТП-50371	0,47	0,13	0,05
ТП-50372	1,06	0,29	
ТП-50374	1,15	0,31	0,18
ТП-50375	1,31	0,35	0,19
ТП-50378	5,03	1,25	0,33
ТП-50308	1,19	0,35	
ТП-50309	0,21	0,06	

ТП-50181

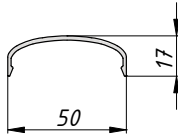

ТП-50181-01

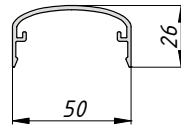

ТП-50182

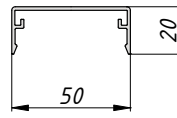

ТП-50182-01

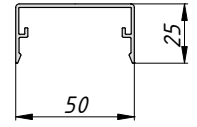

ТП-50182-02

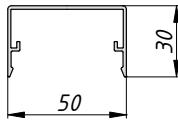

ТП-50182-03

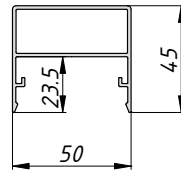

ТП-50182-04

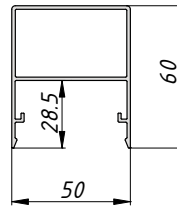

ТП-50182-05

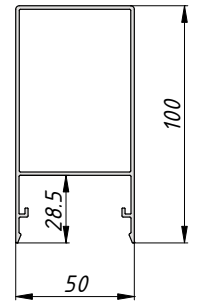

ТП-50183

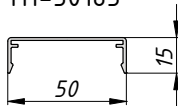

ТП-50184

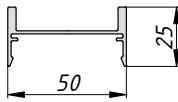

ТП-50185

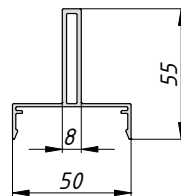

ТП-50186

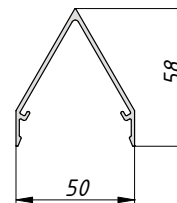

ТП-50187

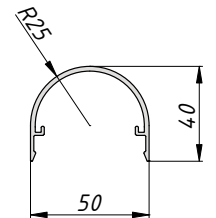

ТП-50184-01

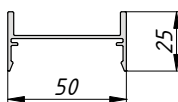

Обозначение	Площадь сечения	Масса 1 п.м.	Площадь покрытия
	см ²	кг	м ² /п.м.
ТП-50181	1.21	0.37	
ТП-50182-01	1.70	0.46	
ТП-50182	1.42	0.38	
ТП-50182-01	1.56	0.42	
ТП-50182-02	1.69	0.46	
ТП-50182-03	2.84	0.77	
ТП-50182-04	3.28	0.89	

Обозначение	Площадь сечения	Масса 1 п.м.	Площадь покрытия
	см ²	кг	м ² /п.м.
ТП-50182-05	4.48	1.21	
ТП-50183	1.06	0.29	
ТП-50184	1.82	0.49	
ТП-50184-01	1.62	0.44	
ТП-50185	2.65	0.72	
ТП-50186	2.37	0.64	
ТП-50187	2.15	0.58	

ТП-5004

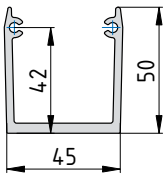

ТП-5005М

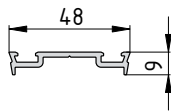

ТП-5011

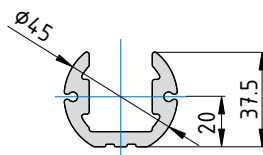

ТП-5014М

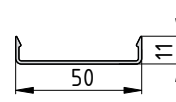

ТП-5015М

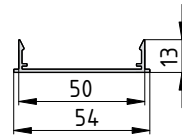

ТП-5021М

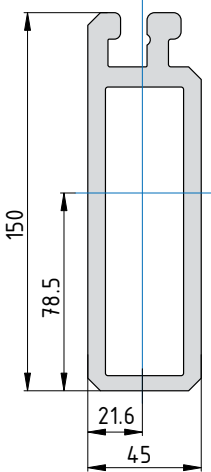

ТП-5045

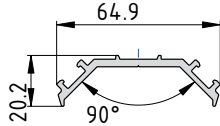

ТП-5046

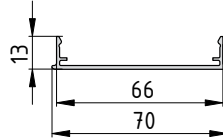

ТП-5051

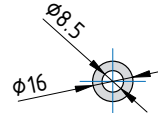

ТП-5094

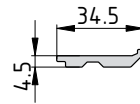

ТП-5095

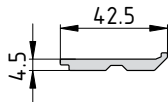

ТП-5096

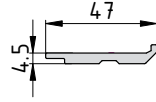

ТП-5097

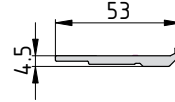

ТП-5098

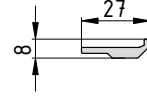

ТП-50215

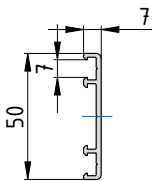

ТПСК-6040

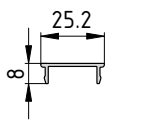

ТПСК-6041

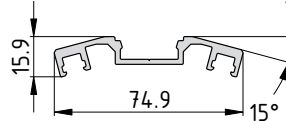

ТПСК-6042

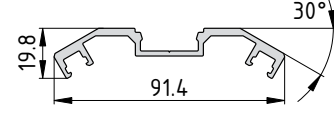

ТПСК-6043

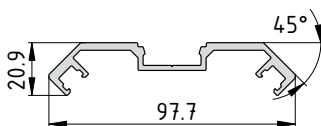

ТПСК-6044

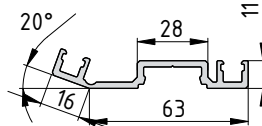

ТПСК-6045

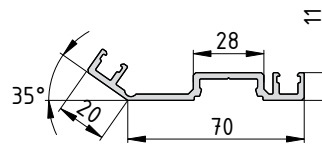

ТП-5009

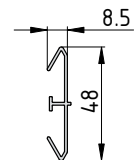

Обозначение	Площадь сечения	Масса 1 п.м.	Площадь покрытия
	см ²	кг	м ² /п.м.
ТП-5004	4.35	1.13	
ТП-5005М	1.35	0.36	
ТП-5011	5.93	1.63	
ТП-5014М	0.89	0.24	0.11
ТП-5015М	1.05	0.28	0.13
ТП-5021М	26.3	7.1	
ТП-5045	2.46	0.66	
ТП-5046	1.40	0.40	0.13
ТП-5051	1.44	0.39	
ТП-5094	1.28	0.35	
ТП-5095	1.64	0.43	

Обозначение	Площадь сечения	Масса 1 п.м.	Площадь покрытия
	см ²	кг	м ² /п.м.
ТП-5096	1.82	0.49	
ТП-5097	1.84	0.50	
ТП-5098	1.03	0.28	
ТП-50215	1.35	0.35	
ТПСК-6040	0.48	0.13	0.05
ТПСК-6041	3.09	0.80	0.19
ТПСК-6042	3.70	0.96	0.22
ТПСК-6043	4.08	1.07	0.26
ТПСК-6044	3.08	0.83	0.27
ТПСК-6045	3.34	0.90	0.29
ТП-5009	0.99	0.27	

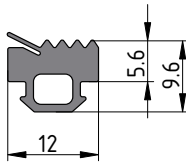
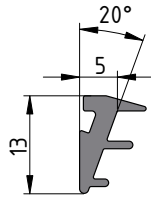
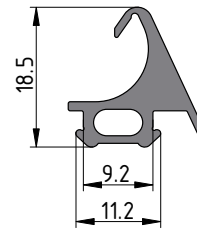
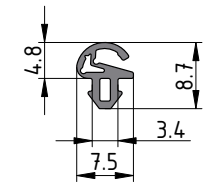
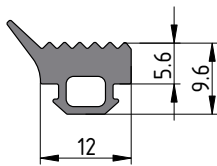
ТПУ-001ММ
 (M=0.075кг/м)

 ТПУ-004ММ
 (M=0.055кг/м)

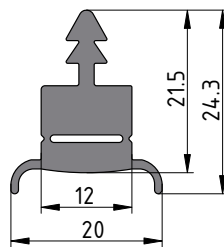
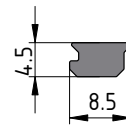
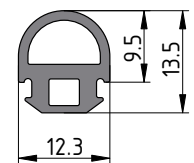
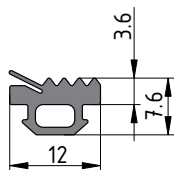
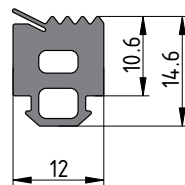
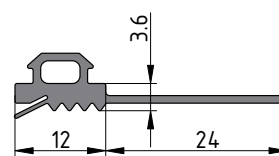
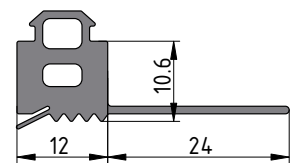
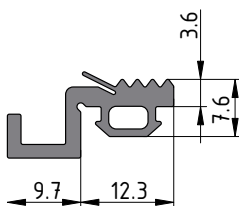
 ТПУ-005-01ММ
 (M=0.11кг/м)

 ТПУ-006-01ММ
 (M=0.031кг/м)

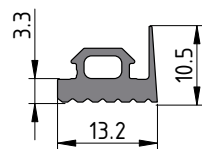
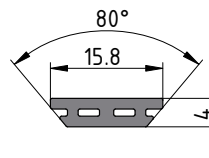
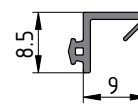
 ТПУ-007ММ
 (M=0.085кг/м)

ТПУ-305

 ТПУ-6005
 (M=0.02кг/м)

 ТПУ-6010
 (M=0.1кг/м)

 ТПУ-6001
 (M=0.066кг/м)

 ТПУ-6002
 (M=0.140кг/м)

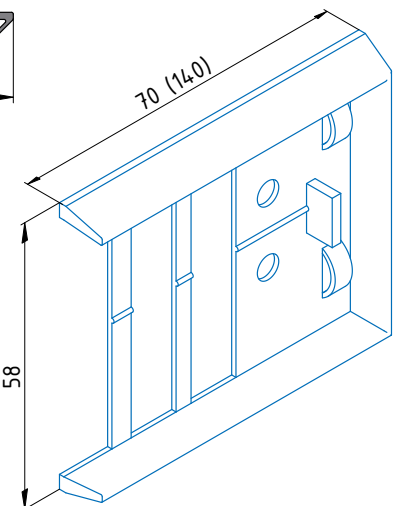
 ТПУ-6001Т
 (M=0.11кг/м)

 ТПУ-6002Т
 (M=0.19кг/м)

 ТПУ-6001К
 (M=0.110кг/м)

ТПУ-6001М

 ТПУ-308
 (M=0,140 кг/м)

 ТПУ-309
 (M=0,073 кг/м)

ТПУ-302 (ТПУ-303)

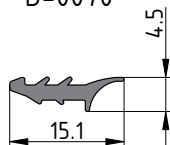

В-0070



ТПУ-6003

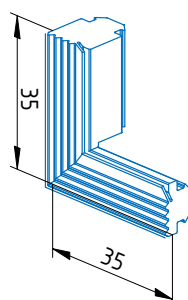

ТПУ-6004

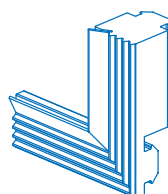

ТПУ-010-03

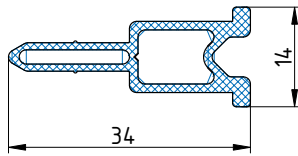

ТПУ-010-04

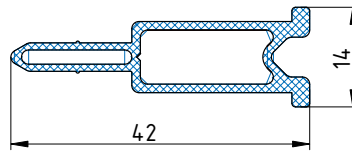

ТПУ-011 /L=100/

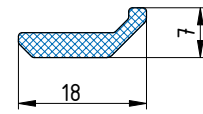

- ТПУ-012 /S=0.5, L=100/
- ТПУ-012-01 /S=1.0, L=100/
- ТПУ-012-02 /S=1.5, L=100/
- ТПУ-012-03 /S=2.0, L=100/

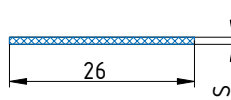

- ТПУ-013 /S=0.5, L=100/
- ТПУ-013-01 /S=1.0, L=100/
- ТПУ-013-02 /S=1.5, L=100/
- ТПУ-013-03 /S=2.0, L=100/

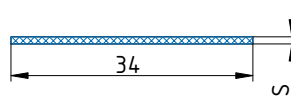

- ТПУ-014 /S=0.5, L=100/
- ТПУ-014-01 /S=1.0, L=100/
- ТПУ-014-04 /S=3.0, L=100/

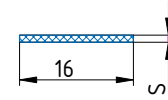

ТПУ-020

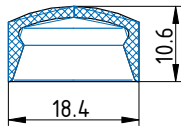

ТПУ-035

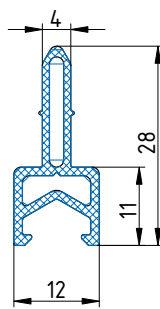

ТПУ-50301

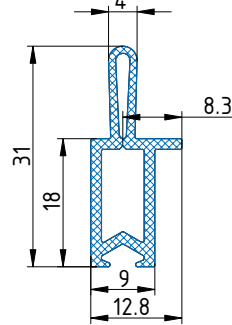

ТПУ-310

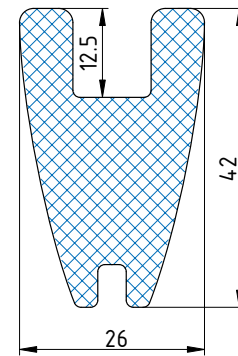

ТПУ-032-07

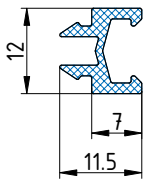

ТПУ-032-14

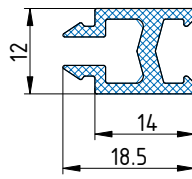

ТПУ-032-18

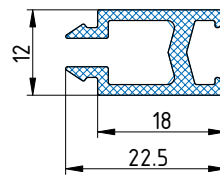

ТПУ-032-26

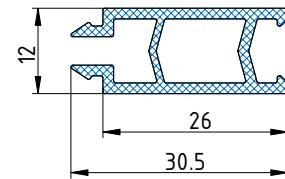

ТПУ-5014

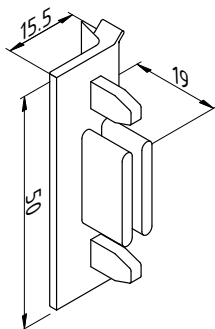

ТПУ-101
(ТПУ-101-01)

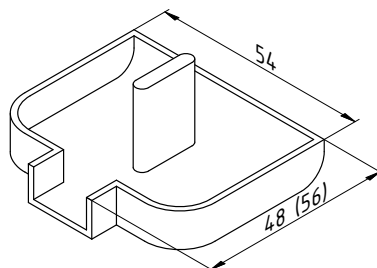

ТПУ-031

